

# CRP4896 - 4' x 8' CNC Machine Kit (Footprint)

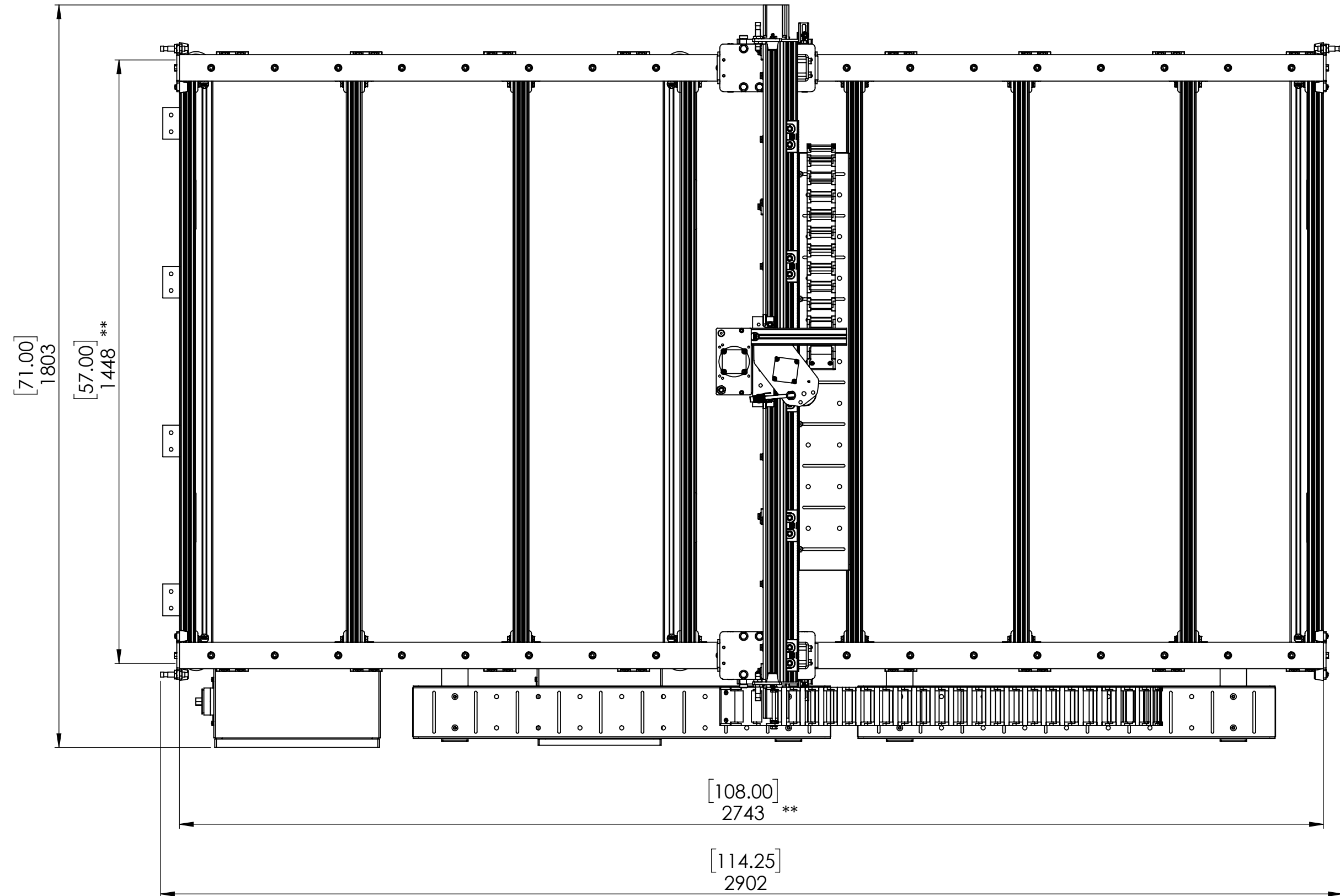

\*\*Dimension to outside edges of extrusion, use this measurement if building your own leg assembly

# Standard Series CNC Machine Kit

## 8" Z-Axis Travel

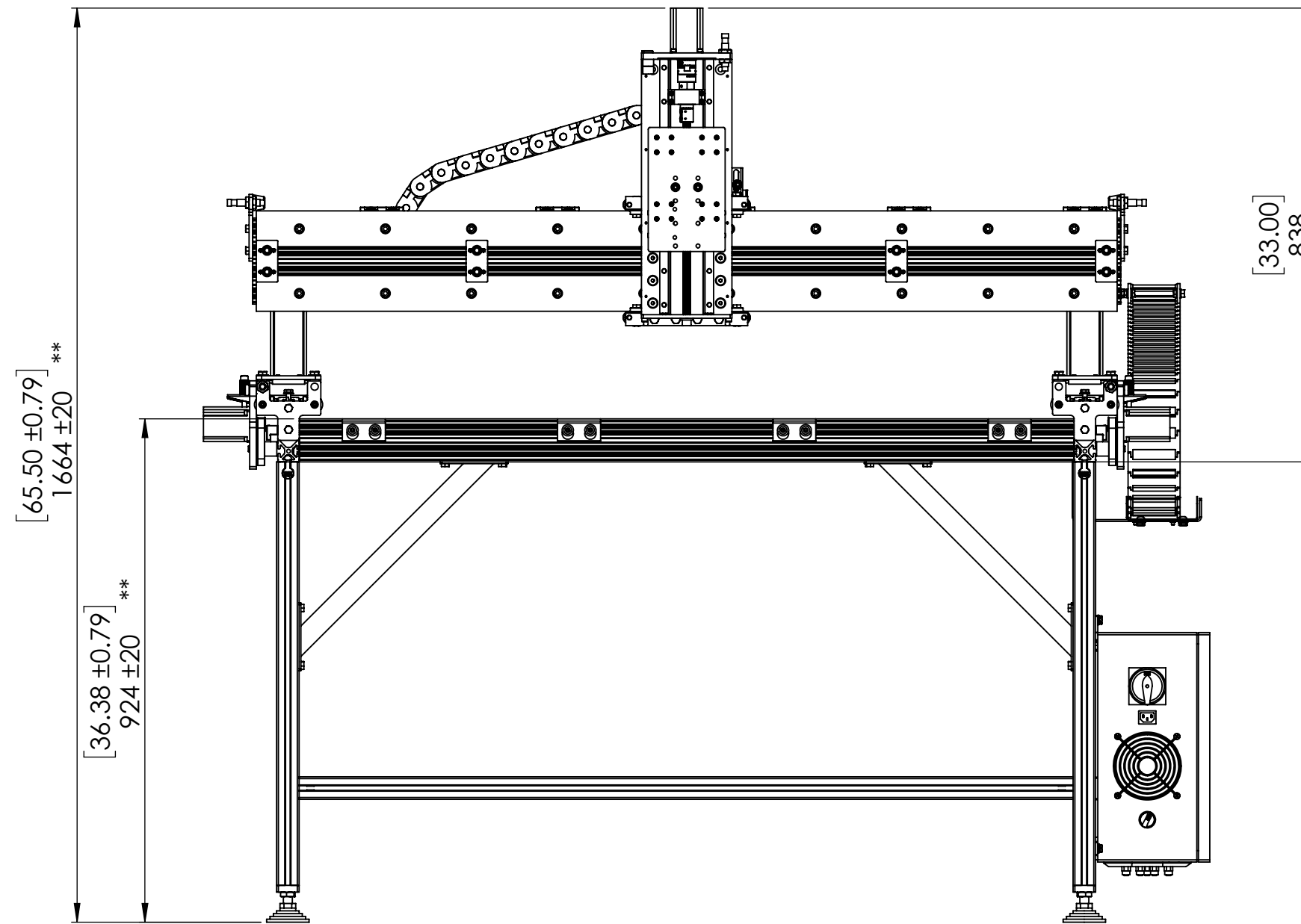

12" Travel Z-Axis will add 100mm (3.94") to top of machine  
\*\*Adjustment of leveling feet in leg kit will impact actual height dimension