

CRP4848 - 4' x 4' CNC Machine Kit (Footprint)

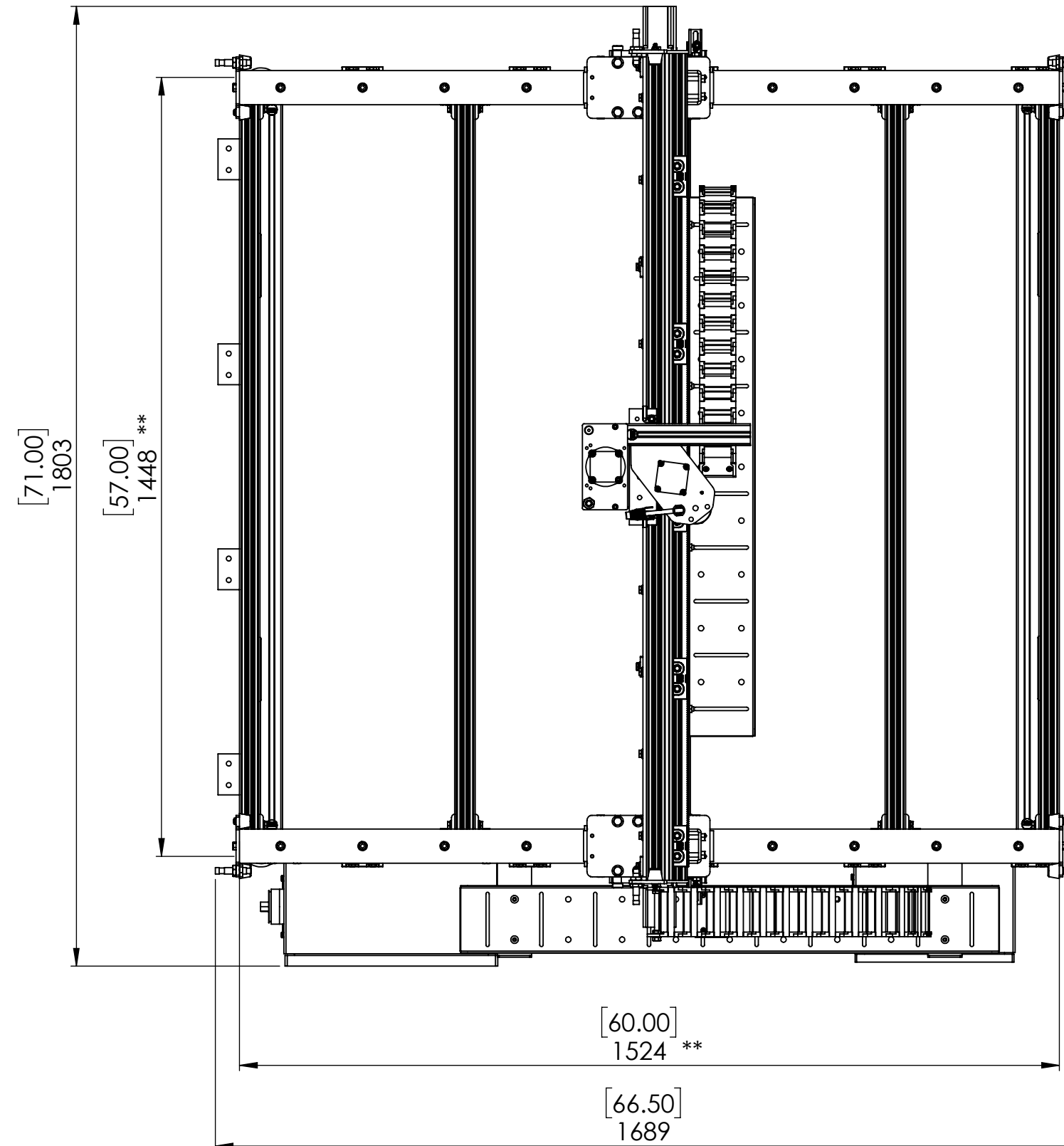

**Dimension to outside edges of extrusion, use this measurement if building your own leg assembly

Standard Series CNC Machine Kit

8" Z-Axis Travel

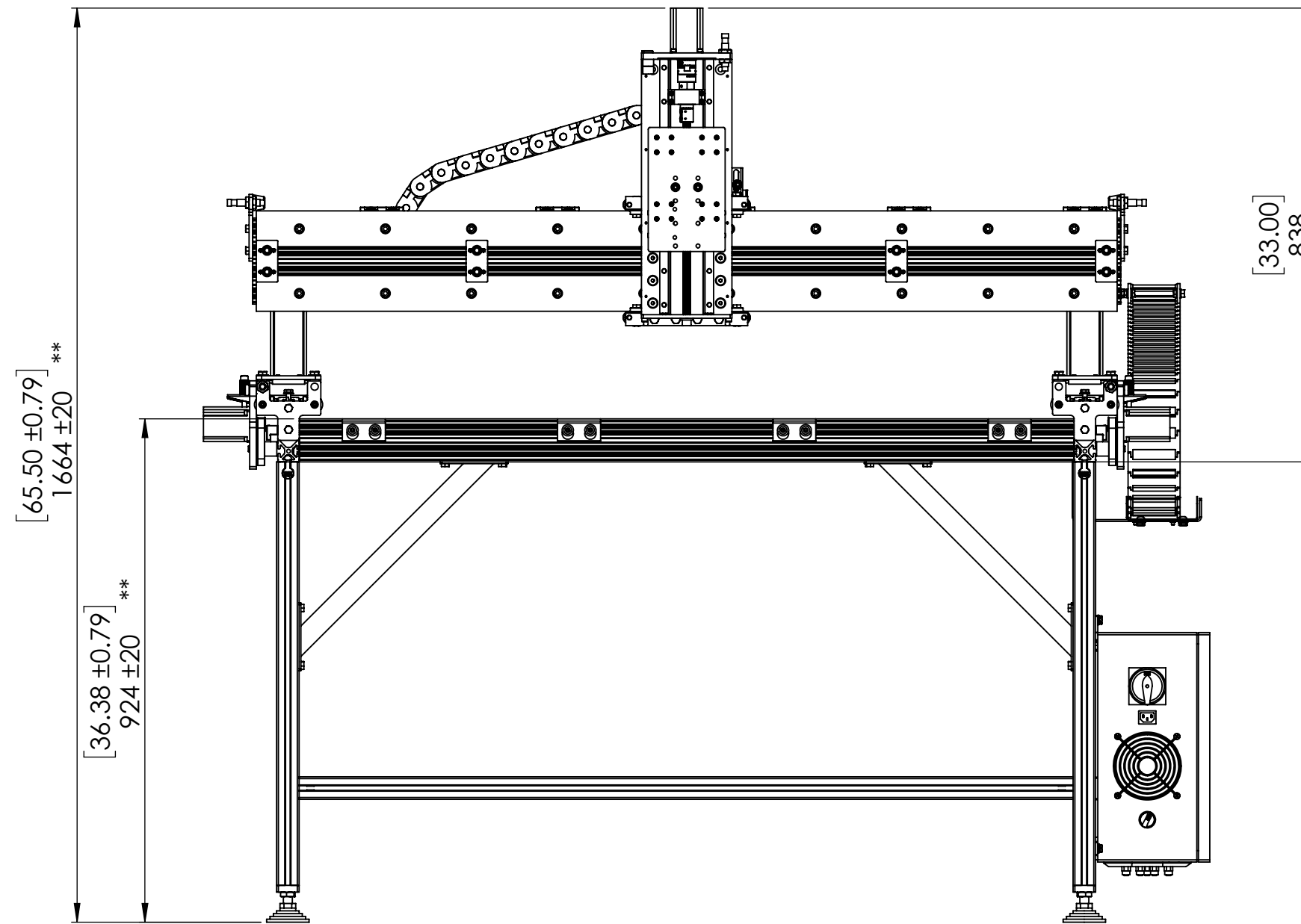

12" Travel Z-Axis will add 100mm (3.94") to top of machine
**Adjustment of leveling feet in leg kit will impact actual height dimension