

CRP142-08 Router Mount

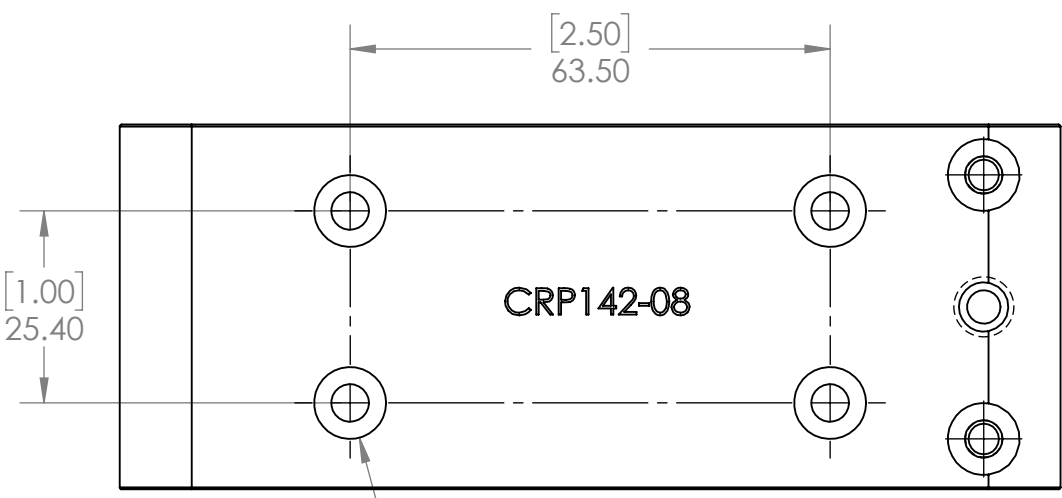

4X ϕ 4.98 [0.20] THRU ALL
Counterbore for M5 Socket Head Screw

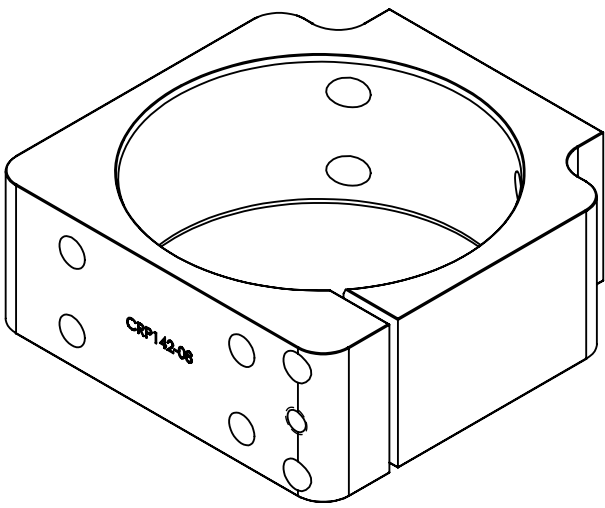
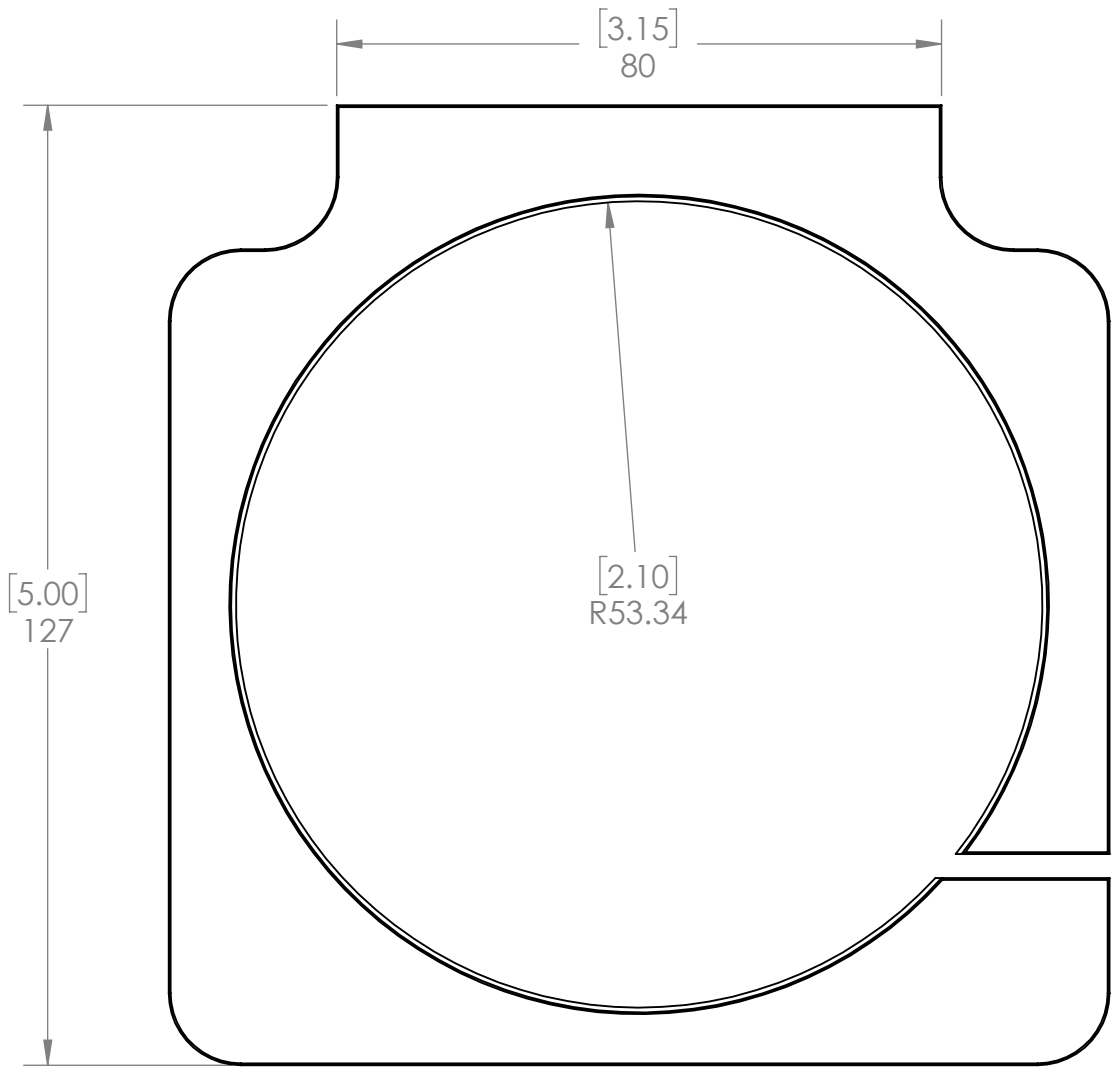